

ALARM PANELS

B|W Signal and Alarm panels are available in many standard packaged units designed for use in a wide range of high, low and intermediate level alarm applications as well as for remote control signalling. Each contains the proper B|W level sensing relays and operates from electrodes set at desired alarm levels.

These panels can also be furnished with one or more B|W pump control relays included in the package to perform any desired level control function. Also these alarm systems can be incorporated into any of the other control systems shown in this catalog.

Contact us for assistance to meet your specific needs.

Catalog Number Example

8040-SC1H-H—L1—N1—1500—S7

ENCLOSURE	
N1	Nema 1
N4	Nema 4
N12	Nema 12

LINE VOLTAGE	
L1	115 Volt 50/60 Hz
L2	208-230 Volt 50/60 Hz

OPTIONAL FEATURES	
X	None
H	Horn instead of Bell

RELAY SENSITIVITY	
S1-S11	Select from Chart Sec. 1500
LF1,HF2	Select from Chart Section 5200
LV1-2 HV3-4-5	Select from Chart Section 5200
V	Select from Chart Section 5300
F1-F8	Select from Chart Section 5300

RELAY TYPE	
1500	Induction Type 1500
5200-L	Series 5200-low sensitivity
5200-H	Series 5200-high sensitivity
5300-P	Series 5300-25 amp contacts

	NUMBER OF ELECTRODES	TYPE OF OPERATION	
SV1H	2	High Level Signal	VISUAL SIGNALS AND ALARMS Signal Lights Only
SV1L	2	Low Level Signal	
SV2	3	High and Low Level Signal	
SV3	4	Three Level Signals	
SV4	5	Four Level Signals	
SV5	6	Five Level Signals	
SA1H	2	High Level Alarm	AUDIBLE SIGNALS AND ALARMS *Bell or Horn Only
SA1L	2	Low Level Alarm	
SA2	3	High and Low Level Alarm	
SASH	2	High Level Alarm	
SASL	2	Low Level Alarm	*Bell or Horn with Two-Position Manual Reset Silence Switch
SC1S	0	Operates from single pole pivot device to indicate any off-normal condition	COMBINATION VISUAL AND AUDIBLE SIGNALS AND ALARMS Signal Lights *Bell or Horn, Pushbutton Silence Switch Automatic Reset
SC1H	2	High Level Signal and Alarm	
SC1L	2	Low Level Signal and Alarm	
SC2	3	High and Low Signal and Alarm	
SC3	4	High and Low Signal and Alarm Intermediate Level Signal	

NOTE: A common electrode is included and it may be omitted if a dependable ground return connection to the liquid is provided by other means.

*Bell with 4 inch gong is standard
85 db. at 10 ft.
Horn is optional
Adjustable 70 to 103 db.

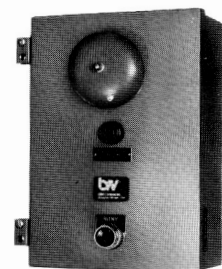

FIXED SEQUENCY PANELS

These arrangements minimize installation time and costs by combining 2 or 3 control functions into a single control panel. All wiring connections between the BIW relays are made in our shop. Field wiring is made to the rugged terminals of the BIW relays and a system wiring diagram is provided which clearly shows all required external connections to the electrodes and other devices.

The standard enclosure is rated Nema 3R for location indoors or outdoors. It is made of steel with baked enamel finish and has knockouts in the bottom for conduit fittings. The Nema 4 watertight

enclosure is fiberglass. It meets the Nema 4X corrosion resistance standards and suitable aluminum conduit hubs are furnished loose for field mounting. Nema 12 enclosures are available to meet industrial requirements, or the relays can be furnished as open chassis on a back plate for field mounting into an electrical panel.

Several of the most common control combinations are listed below and identified with catalog numbers. However, any combination of relays can be provided. Just tell us what you want.

Catalog Number Example

8040-FS2B-X-L1-N12-5200-L-LF1

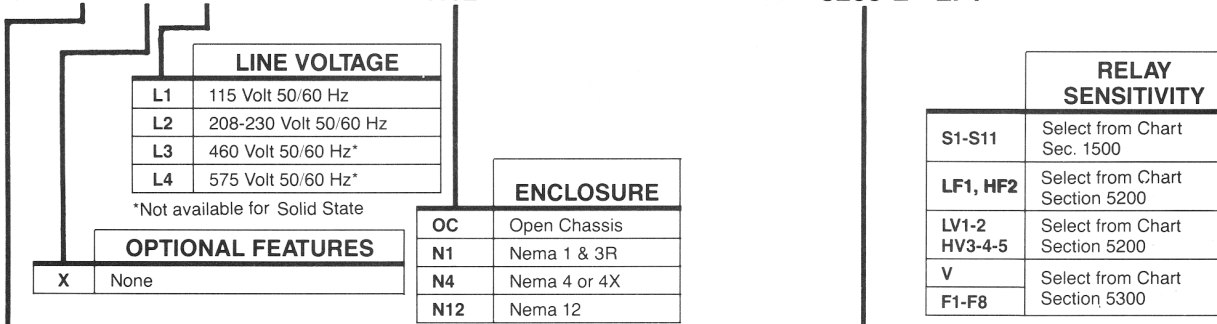

	NUMBER OF ELECTRODES ¹	TYPICAL CONTROLS WITH 2 RELAYS
FS2A	4	Single pump up with high level alarm contact
FS2B	4	Single pump up with low level alarm contact
FS2C	3 & 3	Single pump up control for reservoir with low level cut-off in suction tank or well
FS2D	4	Two pump, pump up fixed sequence-common stop
FS2E	5	Two pump, pump up fixed sequence-separate stops
FS2F	3	Two pump, pump up common stop for ice free electrodes
FS2G	5	Make-up valve control with low level cut-off
FS2H	4	Make-up valve control with low level cut-off and alarm contact
FS2I	4	Hydropneumatic tank control for one pump with low level alarm contact
FS2J	4	Single pump down with high level alarm contact
FS2K	4	Two pump, down fixed sequence with common stop
FS2L	5	Two pump, down fixed sequence with separate stops
FS2M	3	Single pump down with heater cut-off for ice-free electrodes
FS2N	3	High and low level alarm, 1 N.O. and 1 N.C. contact
FS2O	2	High and low alarm contacts for ice-free electrodes

RELAY TYPE	
1500	Induction Type 1500
5200-L	Series 5200-low sensitivity
5200-H	Series 5200-high sensitivity
5300-P	Series 5300-25 amp contacts
5510	Series 5510-10 amp contacts

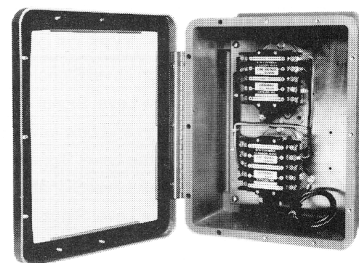

Two Type 1500 Relays In NEMA 4 Enclosure

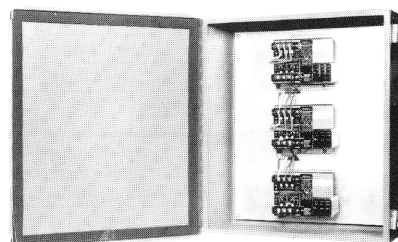

Three Type 5200 Relays In NEMA 12 Enclosure

- NOTES: 1. A common electrode is included and it may be omitted if a dependable ground return connection to the liquid is provided by other means.
2. The alarm contacts provided *close* on alarm condition. Other controls can be furnished with contacts that *open* on alarm condition.

	NUMBER OF ELECTRODES ¹	TYPICAL CONTROLS WITH 3 RELAYS
FS3A	5	Single pump up with high and low level alarm contacts
FS3B	6	Single pump up with high level alarm contact and low level cut-off and alarm contacts
FS3C	5	Single pump up with high and low level alarm contacts for ice-free electrode assembly
FS3D	5	Three pump, pump up with common stop electrode
FS3E	5	Single pump down with high and low level alarm contacts
FS3F	5	Two pump down common stop with high level alarm contact when third pump is required
FS3G	5	Three pump down fixed sequence with high level alarm contact when third pump is required
FS3H	5	Make-up valve control with high and low level alarm contacts
FS3I	4	Make-up valve control with high and low level alarm contacts for shallow tank ice-free electrode assembly
FS3J	4	Make-up valve control with high and low level alarm contacts for standard ice-free electrode assembly
FS3K	4	Three level indication with 1 N.O. and 1 N.C. contacts

AUTOMATIC ALTERNATOR PANELS

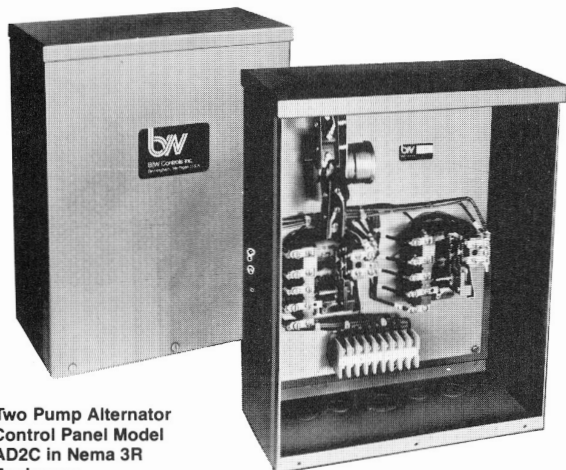

Two Pump Alternator Control Panel Model AD2C in Nema 3R Enclosure

TYPICAL PUMP DOWN SYSTEM

The diagram below illustrates a basic pump down control used on systems for storm drainage condensate return, septic tank effluent, sewage lift stations, water soluble machine tool coolants, and cooling tower sumps.

While any of the BIW relays can be furnished, the Type 1500 induction relays are indicated. These have heavy duty load contacts that are capable of directly operating single phase pumps up to 1 H.P. @ 120 or 240 Volts A.C., or up to size 5 motor starter coils.

The Model AD2C for pump down (or AU2C for pump up) has a common power supply thru the BIW panel to energize the pump control circuits. For many applications it is desirable to have the pump motors and/or their motor starters on their own power supplies. For these situations Model AD2I for pump down or AU2I for pump up) has an isolated load contact for each pump control circuit and should be used.

BIW Control Panel Model AD2C With Type 1500 Relays

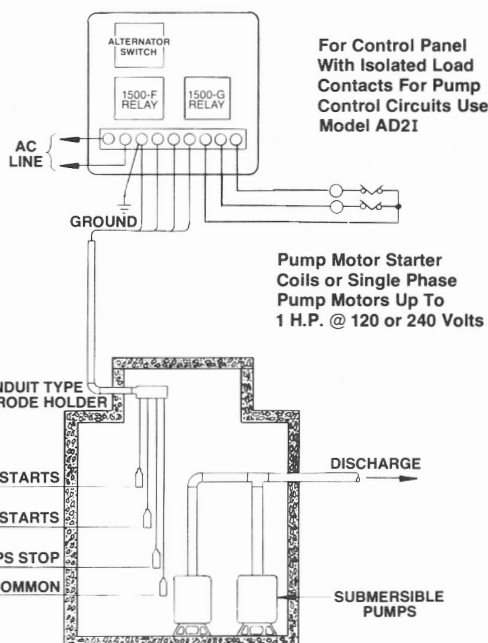

For Control Panel With Isolated Load Contacts For Pump Control Circuits Use Model AD2I

Pump Motor Starter Coils or Single Phase Pump Motors Up To 1 H.P. @ 120 or 240 Volts

BIW Alternators are compact packaged units designed to provide automatic change in the operating sequence of any number of pumps on either "pump down" or "pump up" level control applications. They provide uniform usage of all pumps under normal operating conditions—yet permit use of full pumping capacity during peak load periods.

DESIGN FEATURES

Sequence changing is accomplished with a motor operated switch that has proved its reliability on thousands of applications. This alternator provides momentary time delay to prevent false operation or rapid cycling, and it retains proper sequencing even after a power failure. In addition there are two BIW level detecting relays and all controls are wired to barrier type terminal blocks.

Enclosures are available to meet all indoor and outdoor location requirements. A complete easy to read system wiring diagram is provided showing all of the field connections so that installation is quick and easy.

EXTRA FEATURES

Models can quickly be furnished to meet special application requirements. Extra features include: selector switches, pilot lights, and additional control functions. Alternators can be combined with signals and alarms. Systems complete with motor starters are shown on the following pages.

OPTIONAL SEQUENCING ARRANGEMENTS

The standard method of alternation automatically changes the sequence after each pumping operation after all pumps have stopped. Sometimes other methods of operation may be desirable and Ametek offers a choice. When manual sequence selection is desired, a rotary selector switch is provided and it can be located either on the cover or on the backplate inside the enclosure.

Many systems have continuous flow, and multiple pumps are used to handle the varying load conditions. For these applications BIW has a rotating sequence alternator that will change the pumps in operation whenever there is a significant change in the reservoir level. The pump that has been idle the longest will be added to those running, or the pump that has been running the longest will be stopped. Systems are available for up to 10 pumps.

In addition, BIW alternators can be built to operate fewer pumps than the maximum design number—with provisions made for easy conversion in the field to add the additional pumps when the need arises.

Contact us for assistance to meet your special requirements.

AUTOMATIC ALTERNATOR PANELS

Catalog Number Example

8040-AU2I-X-L2-N4-1500-S8

ENCLOSURE	
OC	Open Chassis
N1	NEMA 1
N3R	NEMA 3R — Only for 2 Pump Alternators
N4	NEMA 4
N12	NEMA 12

LINE VOLTAGE	
L1	115 Volt 50/60 Hz
L2	208-230 Volt 50/60 Hz
L3	460 Volt 50/60 Hz
L4	575 Volt 50/60 Hz

OPTIONAL FEATURES	
X	None
HOA	Hand-off-Auto Switches, one for each pump mounted on cover with data plate
MA	Manual Alteration with sequence selector switch mounted on cover (specify detailed function of selector switch)
ROT	Rotating Sequence Alternation. For 4 or more pumps to equalize flow.

RELAY SENSITIVITY	
S1-S11	Select from Chart Sec. 1500
LF1, HF2	Select from Chart Section 5200
LV1-2 HV3-4-5	Select from Chart Section 5200
V	Select from Chart Section 5300
F1-F8	Select from Chart Section 5300

RELAY TYPE	
1500	Induction Type 1500
5200-L	Series 5200-low sensitivity
5200-H	Series 5200-high sensitivity
5300-P	Series 5300-25 amp contacts
5510	Series 5510-10 amp contacts

STANDARD PUMP DOWN ALTERNATORS

	NUMBER OF PUMPS	NUMBER OF ELECTRODES ¹	CONTROL DESCRIPTION	STANDARD OPERATION
AS2C ²	2	None	Operates from single pole control devices such as relays, pressure switches, etc. Power for motor starter coils comes from B W control panel. (See Note ²)	Pumps are started one at a time on "rising" level and all are stopped simultaneously at the desired "low" level. The starting sequence is then changed for the next cycle of operation.
AD2C	2	4	Power for the starter coils comes from B W control panel.	
AD2I	2	4	Has isolated load contacts which provide for standard two wire control of motor starters or remote control devices.	
AD3I	3	5	Same as AD2I except for number of pumps and electrodes.	
AD4I	4	6	Same as AD2I except for number of pumps and electrodes.	

STANDARD PUMP UP ALTERNATORS

	NUMBER OF PUMPS	NUMBER OF ELECTRODES ¹	CONTROL DESCRIPTION	STANDARD OPERATION
AS2C ²	2	None	Operates from single pole control devices such as relays, pressure switches, etc. Power for motor starter coils comes from B W control panel. (See Note ²)	Pumps are started one at a time on "falling" level and all are stopped simultaneously at the desired "high" level. The starting sequence is then changed for the next cycle of operation.
AU2C	2	4	Power for the starter coils comes from B W control panel.	
AU2I	2	4	Has isolated load contacts which provide for standard two wire control of motor starters or remote control devices. Designed for use with either standard or Ice Free electrode assemblies. Also, for hydropneumatic tank control as well as ordinary pump up systems.	
AU3I	3	5	Has isolated load contacts which provide for standard two wire control of motor starters or remote control devices.	
AU4I	4	6	Same as AU3I except for number of pumps and electrodes.	

Note¹: All alternators listed above are designed for use with one electrode to start each pump and one electrode to stop all pumps. A common electrode is included and it may be omitted if a dependable ground return connection to the liquid is provided by other means.

Note²: No "Relay Type" or "Relay Sensitivity" option available.

AUTOMATIC ALTERNATOR COMBINATION STARTER PANELS

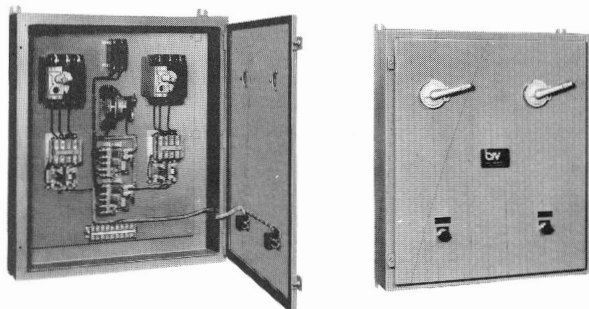

Typical Model C1B Control
In Nema 1 General Purpose Enclosure

FEATURES AND ADVANTAGES

Quick, Easy Installation — All controls assembled in compact enclosures for fast, low-cost installation.

Greater Operator Safety — Operating handles are interlocked with cover and incorporate provisions for padlocks. Handles must be in the OFF position before the control panel can be opened.

Accurate, Reliable Operation — Based on original BIW concept of using the conductivity of liquids as a means of achieving reliable level control.

Minimum Maintenance — All components are conservatively rated, factory tested and performance proven.

STANDARD DUPLEX SYSTEMS

Ametek has developed a number of basic controls for automatic operation of two pumps. The components include a BIW alternator and two BIW relays suitable for the application. Two across the line magnetic starters with 3 pole fixed-trip thermal overload devices are provided along with HOA selector switches on the cover.

There is a choice of thermal magnetic trip circuit breakers, or fusible disconnect switches for motor short circuit protection.

A complete system wiring diagram with description of operation is provided so that field installation and servicing is easily accomplished.

SPECIAL CONTROL SYSTEMS

Basic duplex systems can be equipped with a variety of signals, alarms, meters, remote control or other control accessories. Also, instead of our standard automatic alternation, special sequencing or interlocking arrangements are available. Systems for more than two pumps can quickly be designed and provided.

Catalog Section 8044 shows our ability to provide custom panels. Just tell us what you want to accomplish and Ametek will provide the control system.

TYPICAL STORM DRAIN SUMP CONTROL

Model 8040-D-C3B control panel is shown in the Nema 3 weather tight enclosure with internal dead front cover which is designed for unattended outdoor installations. The electrode will serve to keep the liquid surface clear of debris for proper contact with the electrodes, and it is fabricated from standard pipe and fittings.

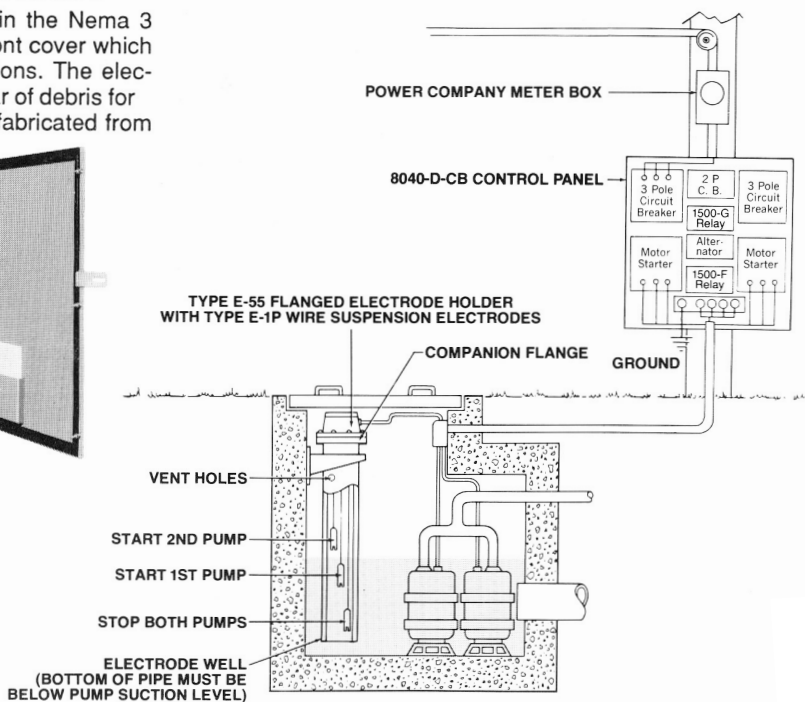
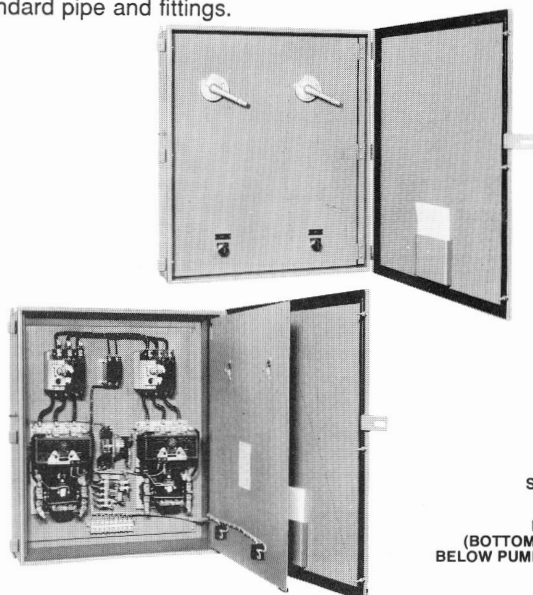

AUTOMATIC ALTERNATOR COMBINATION STARTER PANELS

Catalog Number Example

8040-U-C1B2-HOA-L4-N12 ————— 1500 — S7

ENCLOSURE	
N1	Nema 1
N3	Nema 3 with Internal Deadfront
N4	Nema 4
N12	Nema 12

3 PHASE LINE VOLTAGE	
L2	208-230 Volt 50/60 Hz
L3	460 Volt 50-60 Hz
L4	575 Volt 50/60 Hz

OPTIONAL FEATURES	
X	None
HOA	¹ Hand-Off Auto Switches Furnished as Standard Equipment
PRL	¹ Pump Running Lights
RTM	¹ Running Time Meters

NOTE¹. One can be furnished for each pump Mounted on cover complete with engraved data plate.

RELAY SENSITIVITY	
S1-S11	Select from Chart Sec. 1500
LF1, HF2	Select from Chart Section 5200
LV1-2 HV3-4-5	Select from Chart Section 5200
V	Select from Chart Section 5300
F1-F8	Select from Chart Section 5300

RELAY TYPE	
1500	Induction Type 1500
5200-L	Series 5200-low sensitivity
5200-H	Series 5200-high sensitivity
5300-P	Series 5300-25 amp contacts
5510	Series 5510-10 amp contacts

TYPE OF CONTROL	
D	Pump Down for 2 Pumps
U	Pump Up for 2 Pumps
H	Hydropneumatic Tank with 2 Pumps

	NEMA SIZE	LINE VOLTAGE	MAX. H.P. RATING	CIRCUIT BREAKER	
				Frame Size	Max. Amp ²
C1B2	1	208-230	7½	EA	40
		460	10	EH	30
		550-600	10	FA	20
C2B2	2	208-230	15	EA	70
		460	25	FA	50
		550-600	25	FA	50
C3B2	3	208-230	25	FA	100
		208-230	30	JA	125
		460	50	FA	100
		550-600	50	FA	100
C4B2	4	208-230	50	JA	200
		460	100	JA	200
		550-600	100	JA	175

	NEMA SIZE	LINE VOLTAGE	MAX. H.P. RATING	DISCONNECT SWITCH	
				FUSE CLIP SIZE ³	
C1F2	1	208-230	7½	31-60 ampere	
		460	10	31-60 ampere	
		550-600	10	31-60 ampere	
C2F2	2	208-230	15	61-200 ampere	
		460	25	61-100 ampere	
		550-600	25	61-100 ampere	
C3F2	3	208-230	25	61-100 ampere	
		208-230	30	101-200 ampere	
		460	50	101-200 ampere	
		550-600	50	101-200 ampere	
C4F2	4	208-230	50	201-400 ampere	
		460	100	201-400 ampere	
		550-600	100	201-400 ampere	

ORDERING INFORMATION

In addition to the complete Catalog Number, furnish details on the pump to be controlled including horsepower, voltage and full load current rating.

PANELS WITH CIRCUIT BREAKERS

NOTE². The actual H.P. rating of the motors must be specified so that properly sized circuit breakers can be provided.

4 ELECTRODES REQUIRED

These standard controls are based on two pump start electrodes and one pump stop electrode. A common electrode is included and it may be omitted if a dependable ground return connection to the liquid is provided by other means.

PANELS WITH FUSIBLE DISCONNECT SWITCHES

NOTE³. Fuses are not included. Proper fuses must be provided at time of installation in accordance with N.E.C. requirements.

HYDROPNEUMATIC TANK PANELS

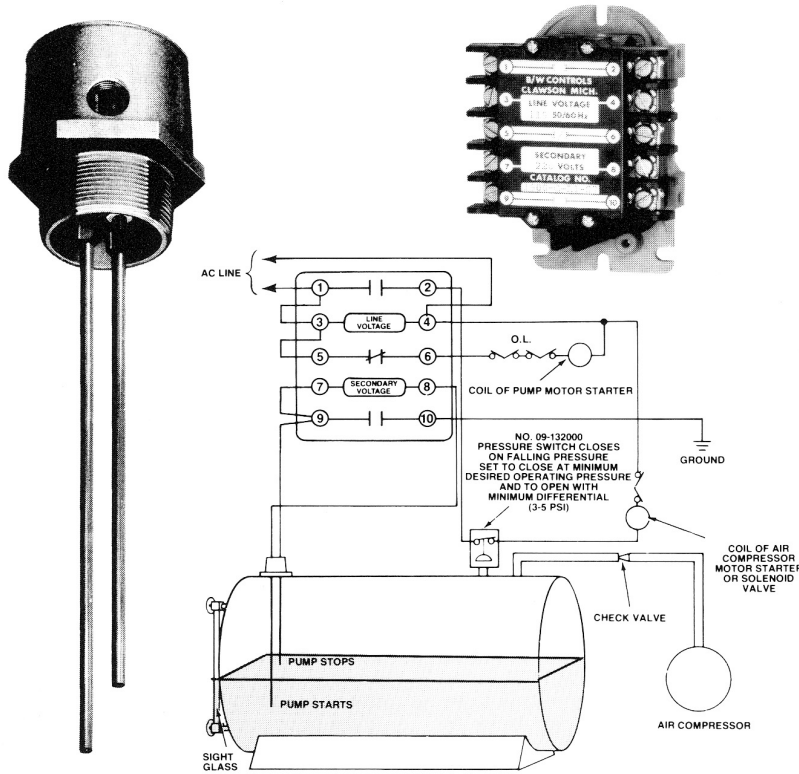

Typical Single Pump Add-Air Type Hydropneumatic Tank Control consists of a Type 1500-G relay and two electrodes of proper type and length supported by a cast pressure tight electrode holder.

BIW hydropneumatic tank control systems provide simple, positive means of maintaining a properly balanced relationship between the water level and air pressure in house tanks for large and small buildings, subdivision water supplies, and other installations that require reliable, trouble-free operation. Fully automatic on start up, it requires little or no maintenance and minimizes short pump cycling during high demand periods.

PRINCIPLE OF OPERATION

As shown at left, the basic single pump add air system consists of BIW Type 1500-G pump control relay which operates from electrodes installed in the tank to start the pump at a low water level and stop the pumping cycle when the water reaches a given high level. The addition of air into the tank is controlled by a pressure switch and is permitted only when the pump is idle. Thus required air is automatically supplied to the tank whenever pressure drops below the desired lower operating pressure and only enough is added to maintain this pressure until the water level falls below the lower electrode and the pump is started again. When the pump starts, the air supply compressor, or solenoid valve, is locked out and the rising water then gradually compresses the air until the desired upper operating pressure is reached. This occurs when the water level has been pumped up to the upper electrode.

The operating pressure differential of the system is determined by the distance between the pump start and pump stop electrodes instead of by the pressure switch differential, it is essential that electrode lengths be properly established to maintain desired air and water balance at all times.

STANDARD ALTERNATOR CONTROL Panel Model 8040-AU2I

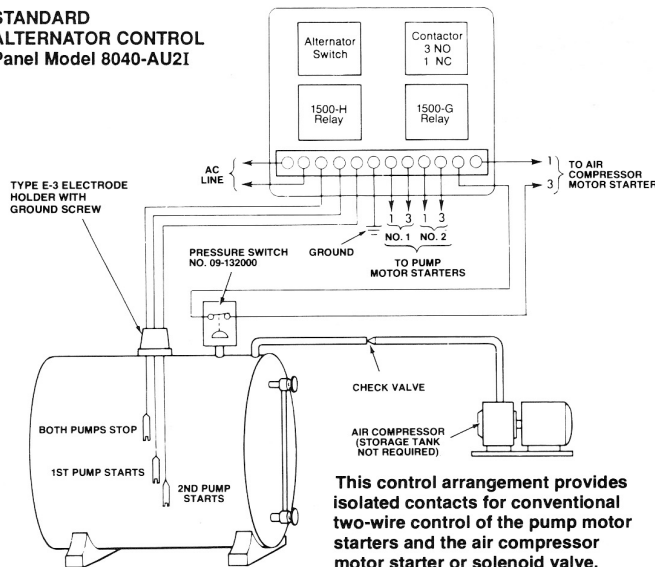

This control arrangement provides isolated two-wire control for conventional two-wire control of the pump motor starters and the air compressor motor starter or solenoid valve. It is suitable for use with up to Size 5 combination starters.

STANDARD COMBINATION MOTOR STARTER Control Panel Model 8040-H-C1B

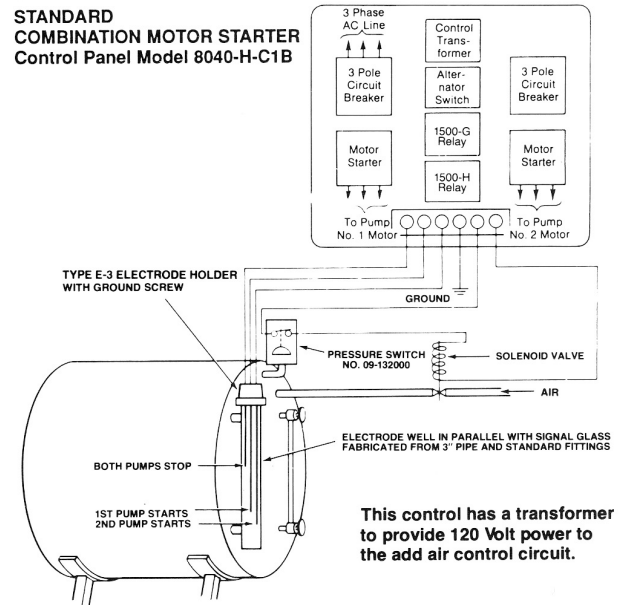

This control has a transformer to provide 120 Volt power to the add air control circuit.

HYDROPNEUMATIC TANK PANELS

ELECTRODE EQUIPMENT

For details on electrode holders see Catalog Section 6012, and for electrode information see Section 6013.

Solid rod electrodes are generally used for applications requiring relatively short lengths of six feet or less to reach desired operating levels. If longer lengths are necessary — or if space limitations prevent installation of rod electrodes, Type E-1P or Type E-1S shielded wire suspension electrodes should be used.

Installation — Electrode holders should be mounted vertically — either through the top of the tank, with electrodes extending downward to the desired operating levels, or in an external chamber installed on the end of the tank as illustrated below.

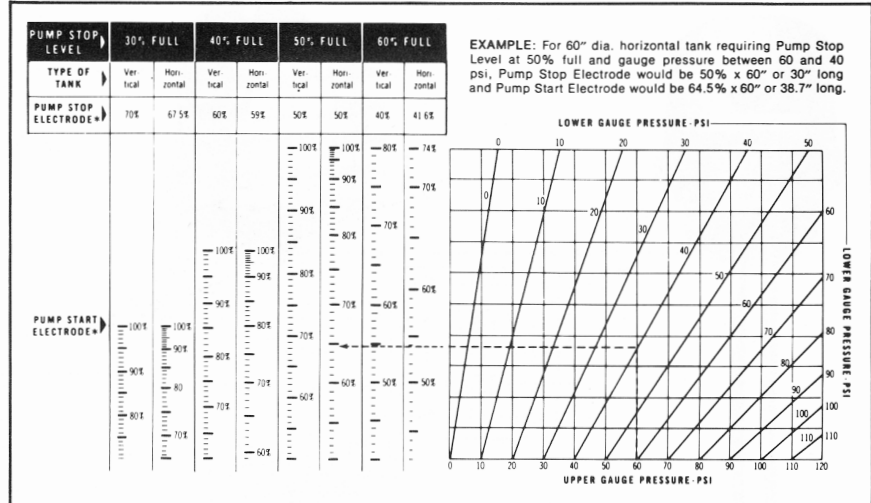
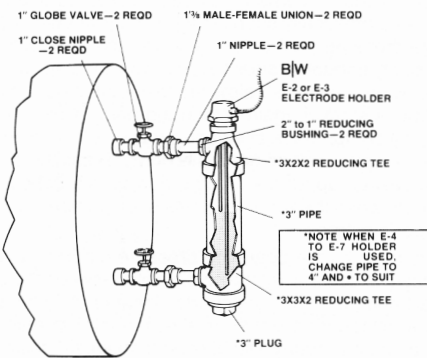

*All electrode lengths are given in per cent of height for Vertical Tanks and per cent of diameter for Horizontal Tanks. Percentage values shown assume electrode holder will be mounted in top of tank.

HOW TO DETERMINE ELECTRODE LENGTHS

Pump STOP Electrode — Select desired Pump Stop Level from the per cent full values listed at top of chart AND NOTE THE PERCENT FACTOR GIVEN FOR Pump STOP Electrode for the type of tank to be controlled. Multiply this percent factor by height or diameter of tank to obtain length of Pump STOP Electrode.

Pump START Electrode — Select desired operating pressure range. Then, starting at

the Upper Gauge Pressure listed on the horizontal scale, draw a vertical line up to intersect the diagonal line shown for desired Lower Gauge Pressure. From this point, draw a horizontal line left to the vertical scale in the column used to determine the Pump STOP Electrode length. Multiply the percent factor shown on scale by the height or diameter of tank to obtain length of Pump START Electrode.

ADD AIR CONTROL

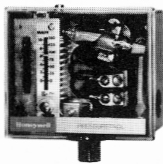

BIW Part No. 09132000
Range 10-150 psi
8.0 Amp @ 115 VAC
5.1 Amp @ 230 VAC

The switch contacts close on falling pressure and must be set to close at the system lower operating pressure. The differential is fixed at approximately 4 psi, so that the addition of air serves only to maintain the system lower pressure. If any other type of pressure switch is used, the operating reset differential must be set to no more than 5 psi.

DISCHARGE AIR CONTROL



BIW Part No. 09132100
Range 10-140 psi
8.0 Amp @ 115 VAC
5.1 Amp @ 230 VAC

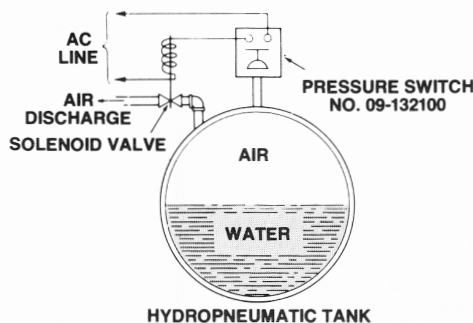

The discharge air control arrangement shown at the left may be added to any basic BIW system, however, it is only required when excess air enters the system from sources such as deep well pumps.

The switch contacts close on rising pressure and should be set about 10 psi above the system upper operating pressure. The reset differential is fixed at approximately 5 psi.

LONG DISTANCE REMOTE CONTROL PANELS

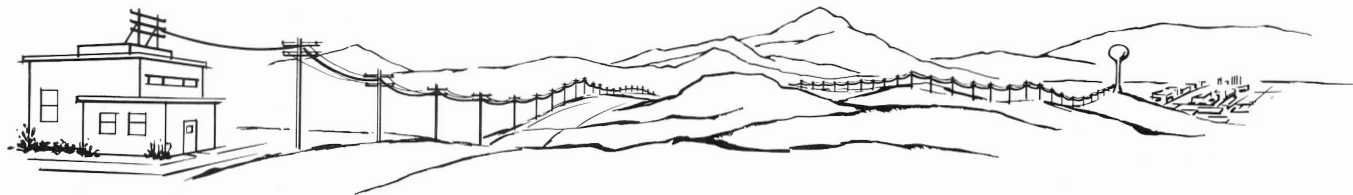

Ametek has developed several B|W long distance and low voltage remote control systems designed to meet the requirements of a broad range of industrial and commercial applications.

While these systems have been widely used with electrodes to detect and control levels and interfaces of conductive liquids and moist bulk materials, they incorporate a low voltage sensing circuit which will also operate from contact-type pilot devices such as pressure, flow, float and limit switches, thermostats and pushbuttons, etc. As a result, they can also be used to provide safe, reliable, low cost control of lighting and alarm systems, conveyors, machinery, and automated processing, packaging and transfer equipment.

Selection of the system best suited for a given application depends

upon the control circuit wiring. In general, maximum distance for an AC sensing circuit is limited by the capacitance of the wires connecting the relay to the pilot device. If a DC sensing circuit is used, distance is limited by the resistance of the control circuit.

For applications requiring an AC sensing circuit use B|W Type 1500 induction relays with 24, 40, or 90 volt secondary coils, or Type 5200-L solid state relays with 270 ohm R1 resistor. For applications requiring a DC sensing circuit use Type 5200-H solid state relay with 10,000 ohm R1 resistor, Type 5300-F1 intrinsically safe control relay, or the 8040-1750 telephone circuit control.

Let our application engineers help you select a system designed to meet your specific needs.

ELEVATED STORAGE TANK CONTROL

A model 8040-U-C1B2 control with combination motor starters is shown with Type 1500 induction relays. This arrangement is suitable located up to 900 feet from the tank. For greater distances, Ametek offers various methods of remote control either over direct private wires or leased telephone circuits.

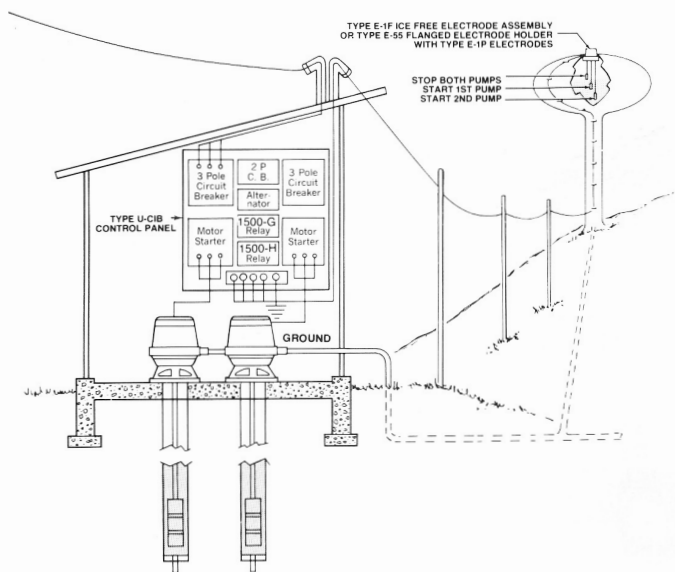

STANDARD 8040-1750 CONTROL PANEL FOR TELEPHONE CIRCUIT REMOTE CONTROL

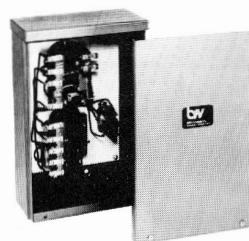

The 1750 control is designed for reliable operation over phone circuits with up to 3000 ohms resistance. A continuous metallic circuit is required between the pilot contact and the 1750 control unit. For installations where an isolated pair is not available, other control systems can be furnished.

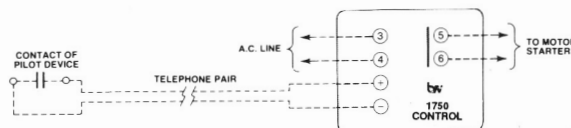

Catalog Number Example
8040—1750—X—L1—N4

LINE VOLTAGE		ENCLOSURE	
115 Volt 50/60 Hz	L1	OC	Open Chassis
230 Volt 50/60 Hz	L2	N1	Nema 1 & 3R
460 Volt 50/60 Hz	L3	N4	Nema 4
		N12	Nema 12

04136200 Lighting Arrestor
(For use on Induction Relay secondary circuits up to 360 volts)

B/W Controls

Long Distance and Low Voltage Remote Control Systems

Application Recommendations

Basic components used in these systems are B/W induction relays and Type 5200-LF1 solid state relays for applications requiring an ac sensing circuit and Type 5200-HF2 solid state relays. Series 8040-1750 control units and Type 5300 intrinsically safe control relays for use where a dc sensing circuit is required.

In most cases, the size of wire is based on the physical strength required to meet given installation conditions. 14 to 18 gauge wire is generally strong enough for private buried or overhead wiring. Telephone circuits and some communication cables use small wires having relatively high resistance. In all cases, however, control circuit wires must have good insulation, and splices or connections must be water-tight and well insulated from ground.

Typical Capacitance and Resistance Values

CONTROL WIRES	CAPACITANCE Mfd./1,000 feet	COPPER WIRE SIZE	RESISTANCE Ohms/1,000 feet
Telephone pair	0.015 mfd	14 gauge	2.6 ohms
Two #14 in open air	0.02 mfd	16 gauge	4.1 ohms
Two #14 in 1/2" conduit	0.04 mfd	18 gauge	6.5 ohms
Two #14 in lead sheath	0.30 mfd	20 gauge	10.4 ohms
Smaller wires have less capacitance.		22 gauge	16.5 ohms
		24 gauge	26.2 ohms
		26 gauge	41.7 ohms

Induction Relay Control Systems

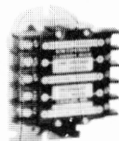

B/W induction relays provide a simple and inexpensive means of controlling production processing functions from remote locations over long distances with the safety inherent in low energy, low voltage control circuit that is isolated from the ac power supply.

Installed near pumps, motors or other operating equipment, they permit use of low-cost light gauge wires for the control circuit to the remote pilot device. Moreover, if an earth ground return is used, all that's required is a single conductor wire.

Following are basic specifications for B/W long distance induction relays. When ordering, please specify line voltage and frequency plus secondary coil voltage required.

Contact Ratings: 1 hp single phase, 115 or 230 volts ac; 25 amperes at 115 or 230 volts ac; standard duty pilot rating up to 600 volts ac.

Primary Coils: Available for all standard voltages up to 600 volts ac at 25 or 50/60 hertz. Maximum power required is 9 volt-amperes.

Secondary Coils: Selection of the proper secondary coil is based upon control circuit parameters as listed in the following tables.

CONTROL CIRCUIT PARAMETER	SECONDARY COILS		
	24 Volt #02-088800	40 Volt #02-088900	90 Volt #02-089000
Maximum distance	30,000 feet	30,000 feet	12,000 feet
Maximum resistance	80 ohms	280 ohms	1400 ohms
Maximum capacitance	16.0 microfarads	4.6 microfarads	0.9 microfarads
Secondary voltage	26 volts	48 volts	106 volts
Short circuit current	220 milliamperes	120 milliamperes	55 milliamperes

8040-1750 Telephone Circuit Control

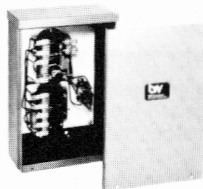

This packaged B/W remote control system is ideally suited to applications over leased telephone circuits and other high resistance or high capacitance control wires. A continuous metallic circuit is required between the pilot contact device and the 8040-1750 control unit. For installations where an isolated pair is not available, other control systems can be furnished.

The 8040-1750 control system is designed for safe, reliable operation. It consists of a transformer to isolate the telephone control circuit from the ac power supply, a filtered low energy dc power supply, and a sensitive dc relay operating a B/W Type 1500-A induction relay. Other B/W induction relays with other load contact arrangements are also available.

Solid-State Relay Control Systems



B/W Series 5200 solid-state relays are offered in two basic types for use in a wide range of low and high sensitivity applications. Both are designed to operate on either 115 or 230 volts ac at 50/60 hertz. Both are capable of performing control functions directly from electrodes or pilot switching devices located several miles away. Both also feature a built-in holding circuit which allows them to operate over a range of levels and from pushbuttons or other momentary contact switches.

In addition, their operating characteristics are virtually unaffected by ambient temperatures ranging from -40°F up to +180°F, or by variations from 80% to 110% of their rated voltage.

Intrinsically Safe Control Systems

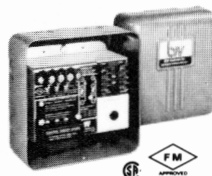

B/W Series 5300 control relays were developed especially to provide an intrinsically safe and economical means of detecting and controlling a wide range of processing variables in areas where a potentially explosive atmosphere may exist. Designed to operate on 115 or 230 volts ac at 50/60 hertz, they have been tested and approved by Factory Mutual for use in applications involving Class I areas. When properly installed, they provide an external probe or pilot control circuit that is inherently incapable of releasing sufficient electrical energy to ignite even the most flammable or volatile gases and vapors classified in Groups A, B, C and D. Accordingly, they may also be used in Class II and Class III locations.

Series 8040

B|W Controls

Control Panels

COPPER WIRE SIZE	SINGLE WIRE WITH GROUND RETURN		
	Maximum Recommended Distances		
	24 Volt Secondary	40 Volt Secondary	90 Volt Secondary
14 gauge	30,000 feet	30,000 feet	12,000 feet
16 gauge	18,000 feet	30,000 feet	12,000 feet
18 gauge	12,000 feet	30,000 feet	12,000 feet
20 gauge	6,000 feet	23,000 feet	12,000 feet
22 gauge	4,000 feet	15,000 feet	12,000 feet
24 gauge	2,500 feet	9,000 feet	12,000 feet
26 gauge	1,500 feet	6,000 feet	12,000 feet

COPPER WIRE SIZE	REMOTE CONTROL THROUGH LOOP CIRCUIT		
	Maximum Recommended Distances		
	24 Volt Secondary	40 Volt Secondary	90 Volt Secondary
14 gauge	15,000 feet	30,000 feet	12,000 feet
16 gauge	9,000 feet	30,000 feet	12,000 feet
18 gauge	6,000 feet	21,000 feet	12,000 feet
20 gauge	3,500 feet	13,000 feet	12,000 feet
22 gauge	2,000 feet	8,000 feet	12,000 feet
24 gauge	1,200 feet	5,000 feet	12,000 feet
26 gauge	800 feet	3,000 feet	12,000 feet

Single conductor remote control using ground return.

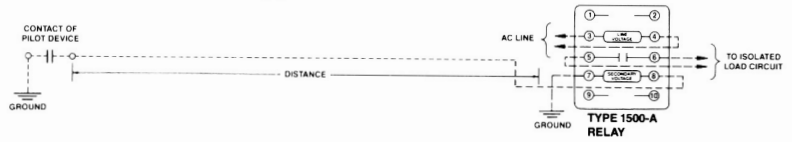

Remote control through a loop circuit.

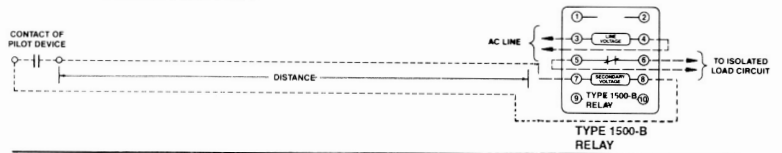

Remote control through a loop circuit. Control wires are overhead with lightning arrester protection.

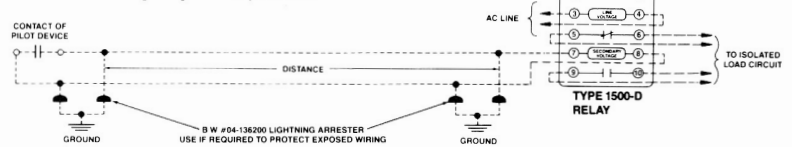

In operation, the control system applies 57 volts dc to the telephone circuit, with current inherently limited to 18 milliamperes even on a direct short circuit. The distance between the 8040-1750 and a remote pilot device is limited only a maximum allowable circuit resistance of 3000 ohms and a maximum circuit capacitance of 150 microfarads. Power required is 16 volt-amperes.

Available in models to operate from all standard voltages up to 600 volts ac at 25 or 50/60 hertz, these systems are equipped with heavy duty load contacts. Rating are: 1 hp, single phase, 115 or 230 volts ac; 22 amperes at 115 or 230 volts ac; standard duty pilot rating up to 600 volts ac.

Dual function remote control over a single telephone pair.

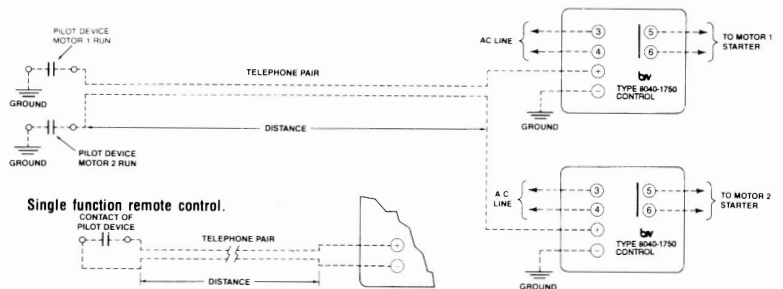

Single function remote control.

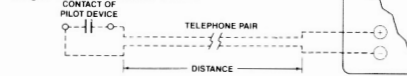

8040 Control Panels Continued

Contact Ratings: 10 amperes at 120 or 240 volts ac or 28 volts dc; 1/4 hp at 120 volts ac and 1/3 hp at 240 volts ac.

Contact Arrangement: DPDT load contacts plus SPDT holding circuit contacts.

Power Requirement: 9 volt-amperes, 6 watts.

Low Energy Control Circuit Parameters:

Type 5200-LF1 Relay with 270 ohm R1 resistor: Output—8 volts ac. Current—30 milliamperes. Maximum circuit resistance—200 ohms. Maximum capacitance—3.7 microfarads.

Type 5200-HF2 Relay with 10,000 ohm R1 resistor: Output—9.6 volts dc. Current—1 milliampere. Maximum circuit resistance—9,600 ohms. Maximum capacitance—120 microfarads.

Single function remote control with Series 52 solid state relay operating from pilot switch.

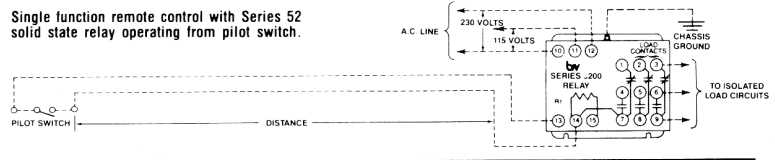

Series 52 solid state relay with built in holding circuit operating from pushbutton contacts.

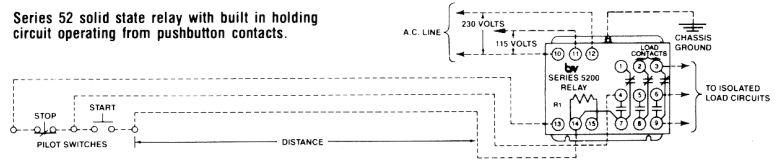

Contact Ratings: 25 amperes resistive load at 120 or 240 volts ac and 24 volts dc; 1 hp at 120 volts ac and 2 hp at 240 volts ac.

Contact Arrangement: DPDT load contacts plus SP normally open holding circuit contact.

Power Requirement: 9 volt-amperes, 6 watts.

Control Circuit Energy: Inherently limited to less than 1 milliampere at 9.6 volts dc to assure intrinsically safe operation under any abnormal fault conditions.

Control Circuit Parameters: Type 5300-S-F1 relay with 10,000 ohm sensitivity resistor: Maximum circuit resistance—9,600 ohms. Maximum capacitance—120 microfarads.

Intrinsically safe remote control with Series 53 relay operating from contacts of a pilot switch.

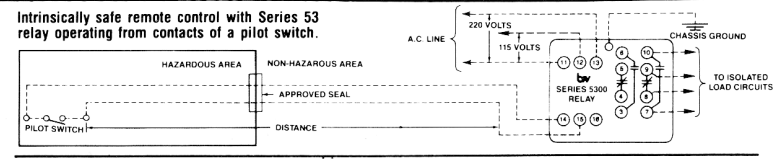

Series 53 relay with intrinsically safe holding circuit operating from the contacts of two pilot switches.

