

# Fahrenheat®

## PHH SERIES PORTABLE ELECTRIC HYDRONIC HEATERS

- SAFE, CLEAN, QUIET HEAT ANYWHERE IT'S NEEDED.
- EUROPEAN STYLING, ATTRACTIVE FINISHED COMPLIMENTS ANY DECOR.
- HEATS EVENLY TO REDUCE ROOM TEMPERATURE VARIATIONS.
- AUTOMATIC THERMOSTAT AND HIGH-TEMPERATURE SHUT-OFF

### APPLICATIONS

Fahrenheat PHH series hydronic heaters combine the comfort and safety of traditional heating systems with the freedom and mobility of portable heating systems. They provide uniform, gentle floor-to-ceiling warmth and comfort for use in the bathrooms, and small areas in homes, apartments, condos and offices.

### FEATURES

**MULTIPLE WATTAGES** – Dual heat model PHH15002 lets user select 750 or 1500 watts with a turn of a dial.

**AUTOMATIC THERMOSTAT** – Automatic thermostat lets you maintain desired comfort level. Merely dial up or down to the level of comfort you prefer. The thermostat will automatically control the heater to maintain that level. Heater design produces gentle, radiant heat even after the thermostat's been satisfied.

**CONTEMPORARY STYLING** – Rounded top design and Northern White color blends with any room decor. Tuck-away carrying handle incorporated into the heater body.

**UNIFORM HEAT TRANSFER** – Specially formulated liquid filled reservoir and large copper element maximizes heat retention while oversized aluminum fin surface provides uniform heat transfer the entire length of the heater, assuring safe operating temperatures well below conventional baseboards.

**AUTOMATIC THERMAL CUTOUT** – Linear high temperature cut-out safety checks the entire length of heater and will automatically shut off heater in the event of accidental air blockage.

**NO MAINTENANCE SEALED SYSTEM** – Nothing to fill or replace. No piping, plumbing or water supply. Liquid solution is permanently sealed.

**SAVES ENERGY** – Between power-on cycles, stored up heat from the liquid filled element keeps on radiating warmth more efficiently than other heaters. Hydronic heaters are energy-efficient because 100% of the heat generated is convected into the room. Individual room control means energy costs are lower than when central heat is wasted on unused rooms.

### Positive Off Thermostat



When thermostat is in the "OFF" position unit is de-energized.

### HI / LO Wattage Switch



When the switch in the left position, the unit is operating at 750 watts. When the switch is in the right position it is operating at 1500 watts.

### Pilot Light

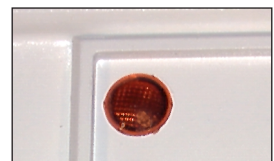

Lets you know heater is operating. When you energize the heater the light goes on.

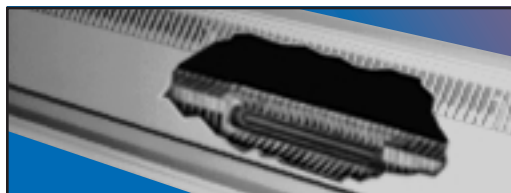

### SELECTION CHART

CATALOG NO.	VOLTS	WATTS	BTU/HR.	AMPS.	SIZE	SHIP WT.
PHH15002	120	750 1500	2560 5120	6.3 12.5	46"L X 7.25"H X 4.5"D	14lbs.

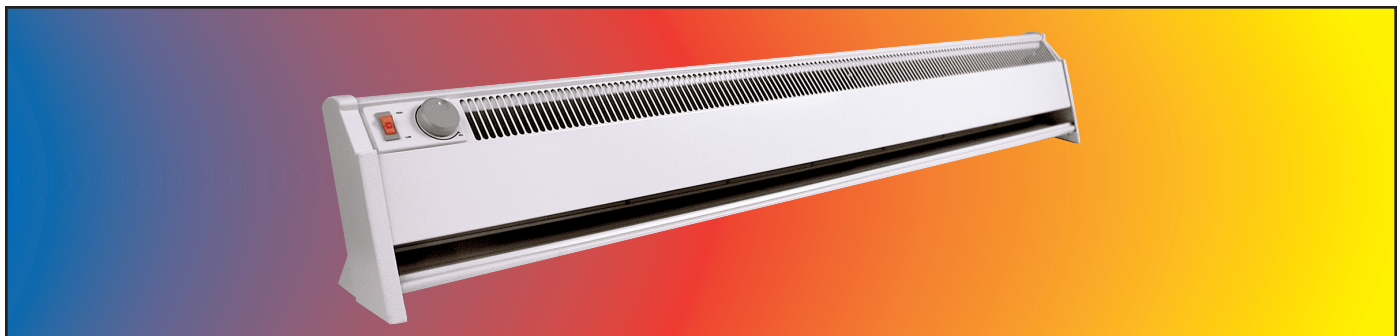

# MODEL PHH15002

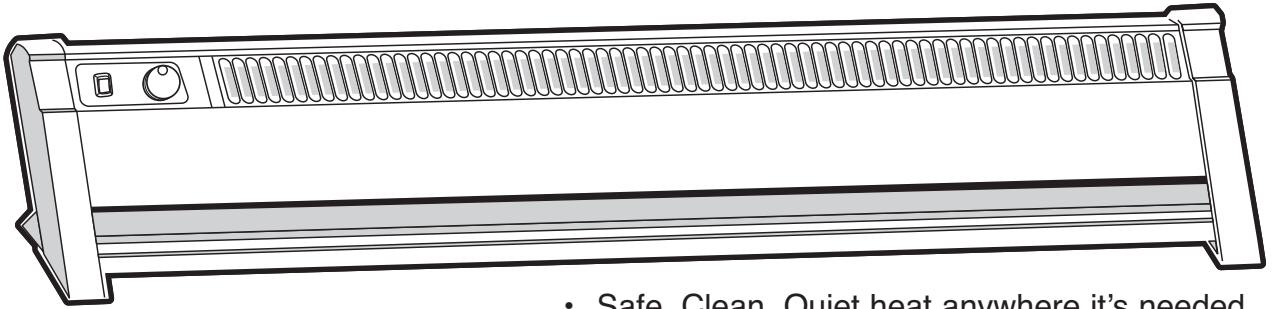

- Safe, Clean, Quiet heat anywhere it's needed.
- European styling, attractive finished compliments any decor.
- Heats evenly to reduce room temperature variations.
- Automatic thermostat and high-temperature shut-off

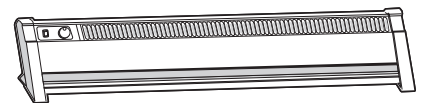
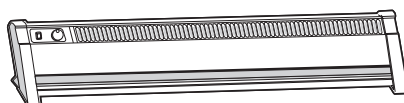
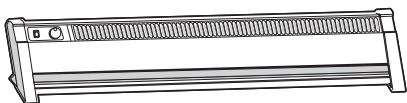
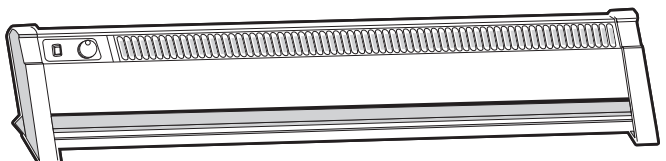
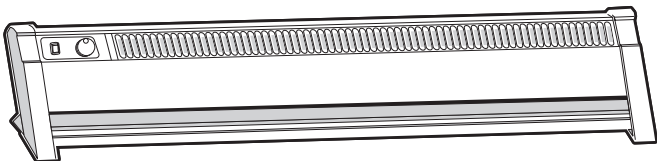
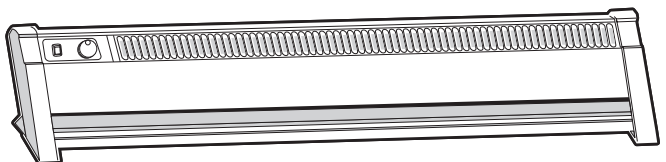
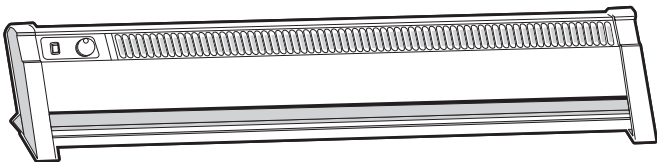

**Marley**  
Engineered Products

An **SPX** Company

470 Beauty Spot Road East  
Bennettsville, SC 29512  
[www.marlymep.com](http://www.marlymep.com)