

BRH SERIES CONTRACTOR AIR HEATERS

- BUILT-IN THERMOSTAT
- BUILT-IN HANDLE / CORD STORAGE
- SAFETY HIGH TEMPERATURE LIMIT
- 6' HEAVY DUTY CORD WITH PLUG

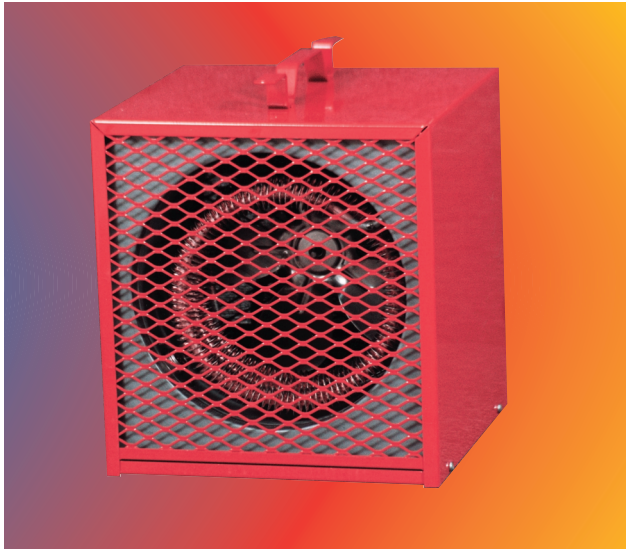

For construction job sites, commercial workshops and other large unheated areas.

- Industrial, finger proof, steel intake and discharge grilles.
- Red Finish.
- Steel spiral fin brazed to metal sheathed element for maximum heat transfer.

- Quiet.
- Permanently lubricated motor.

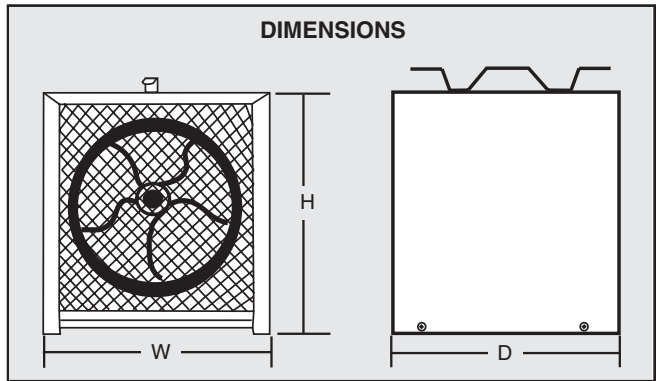
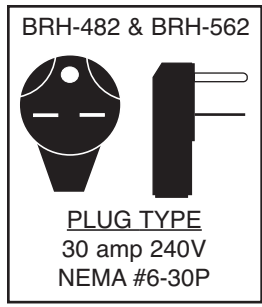
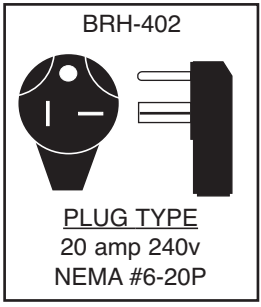

CATALOG NO.	H(in.)	W(in.)	D(in.)
BRH-402	14	10.5	11
BRH-482	14	10.5	11
BRH-562	14	10.5	11

SELECTION CHART

CATALOG NO.	UPC.	VOLTS	PH	WATTS	BTU/HR	AMPS	PLUG TYPE	WT(LBS.)
BRH-402	0 98319 86200 6	240/208	1	4000/3000	13,650/10,238	16.7/14.4	#6-20P	17
BRH-482	0 98319 86202 0	240/208	1	4800/3600	16,380/12,285	20.0/17.3	#6-20P	17
BRH-562	0 98319 86201 3	240/208	1	5600/4200	19,110/14,333	23.3/20.2	#6-20P	19

MODEL BRH

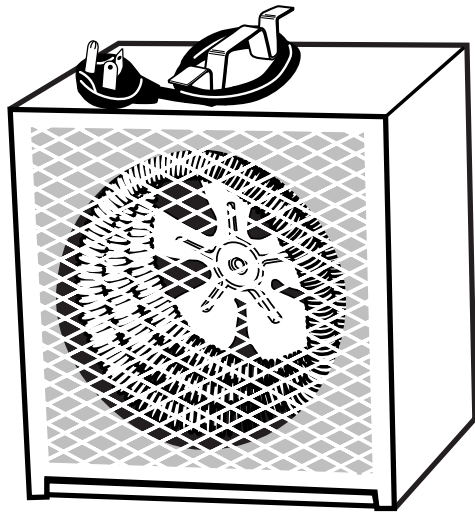

- Built-in thermostat
- Safety high temperature limit
- Built-in handle / cord storage
- 6' Heavy duty cord with plug

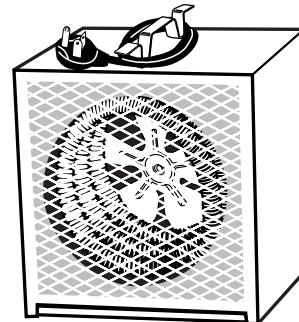
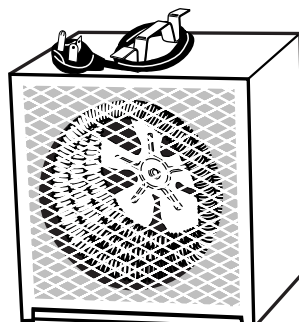
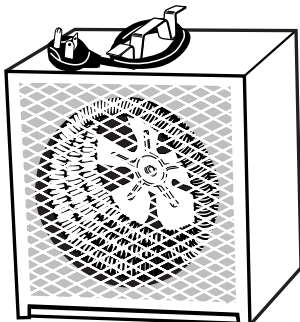
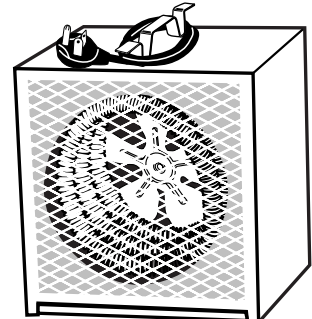
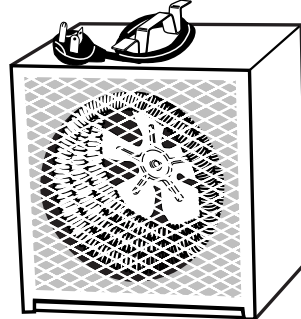
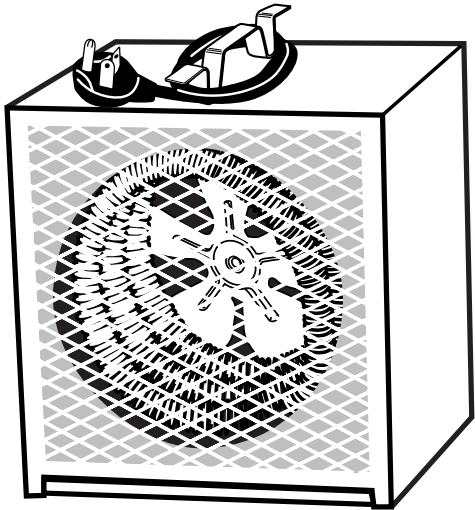
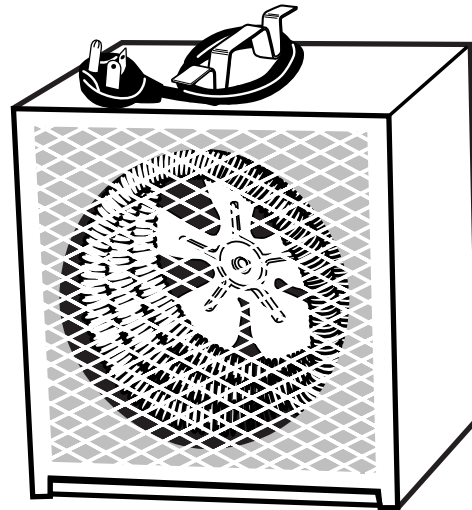

Marley
Engineered Products

An **SPX** Company

470 Beauty Spot Road East
Bennettsville, SC 29512
www.marleymep.com