



# SERIES 08-02



## Precision Snap Disc Thermostats Surface Mounting Type

8.10.12

### FEATURES

- Ratings to 12A at 240VAC
- 100,000 Cycle Rating
- UL Component Recognized 
- CSA Certified 
- CE Compliant 
- Tamper-Proof Preset Temperature
- Calibrated Settings from 35 to 350°F (2 to 176°C)
- Automatic Reset
- Vibration Resistant

### APPLICATIONS

- Power Supplies
- Solar Heating
- Copiers
- Communications Equipment
- Refrigeration Compressors
- Welding Equipment
- Food Processing

### DESCRIPTION

A snap-acting bimetal disc serves as the actuating element in these rugged, precision thermostats. As the temperature reaches the tamper-proof predetermined set point, the disc snaps to provide rapid, positive contact action minimizing radio frequency interference and ensuring high reliability.

These thermostats are individually calibrated and tested to meet both thermal and electrical characteristics. The single contact switch arm assembly minimizes failures due to contact contamination, while the fine silver contacts assure long life and excellent current carrying capacity. Resistance to vibration and harsh environments are additional features.

The polyphenylene sulfide base and metal cap provide protection from contamination and an optional epoxy seal improves resistance to harsh environments.

Many terminations and mounting assemblies are available to permit great flexibility in installation.



Thermostats feature current carrying capacities up to 12A at 240VAC measuring .350" in height. An optional epoxy seal provides additional protection against contamination.

### TEST SAMPLES

Operating samples can be supplied for application tests. A completed Fenwal Snap Disc Application Data Form is required to select and produce an operating sample. Application Data Forms are available from Fenwal or your local Fenwal sales representative.

Selected 08-02 models can be ordered from the Quick Ship Program for next day delivery. Consult Quick Ship brochure.

# SPECIFICATIONS

## Switch Action

SPST (normally open or normally closed)

## Dielectric Strength

1500 VAC terminals to case.

## Insulation Resistance

100 Megohms minimum at 500VDC.

## Vibration

MIL-STD-202D, Method 204B, 10 G's.

## Shock

MIL-STD-213B, Test Condition K, 30 G's, 11 millisc.

## RANGES AND TOLERANCES

**TABLE 1**



Series	Temperature Range	Tolerances		Differential (Nominal)
		Open	Closed	
08-02	35 to 240°F 2: to 115°C	± 7F° ± 4C°	± 7F° ± 4C°	20F° 11C°
	241 to 300°F 116 to 148°C	± 7F° ± 4C°	± 8F° ± 4.5C°	25F° 14C°
	301 to 350°F 149 to 177°C	± 8F° ± 4.5C°	± 10F° ± 6C°	30F° 17C°

NOTE: Differences in temperature testing procedures and equipment, between those of the manufacturer and the customer, can result in temperature variances of up to 2°F.

## ELECTRICAL RATINGS (Resistive)

**TABLE 2**

Series	120VAC	240VAC	30VDC	Cycles	Approvals
08-02	12A 120VA	12A 120VA	2A —	100,000 100,000	

 and  units rated for AC operation only.  
U.L. File E18974, Guide XAPX2.  
C.S.A. File LR 7378, Class 4823 02.  
Certified by BG Technology 

**TABLE 3**

## Mounting Bracket

- B1—No Bracket (Cap Only)
- B2—Bottom Oval Flange
- B6—Stud Mounting Screw

## Cap and Mounting Flange Material

- C3—Stainless Steel

## Mounting Hardware Size

- H1—No hardware (use with B1)
- H4—#6 screw for flange mounting
- H5—#8 screw for flange mounting (B4 only)
- H6—#6 screw for stud mounting

## Terminals Positions

- T1—Eyelet, opposed horizontal
- T2—Eyelet, opposed vertical
- T3—Eyelet, parallel horizontal
- T4—Eyelet, parallel horizontal, reverse step
- T6—1/4" Quick Connect, opposed horizontal
- T7—1/4" Quick Connect, opposed vertical
- T10—Leads, opposed horizontal
- T11—Leads, opposed vertical
- T12—Leads, parallel horizontal
- T13—Leads, parallel vertical
- T14—Vertical lead wires with epoxy filled mylar sleeve

## Lead Wires (specify length)

- L1—No Lead Wires
- L2—105°C PVC, 18 AWG, 600V insulation
- L3—200°C TFE, 18 AWG, 300V insulation
- L4—250°C TGGT, 18 AWG, 300V insulation

# OUTLINE DIMENSIONS

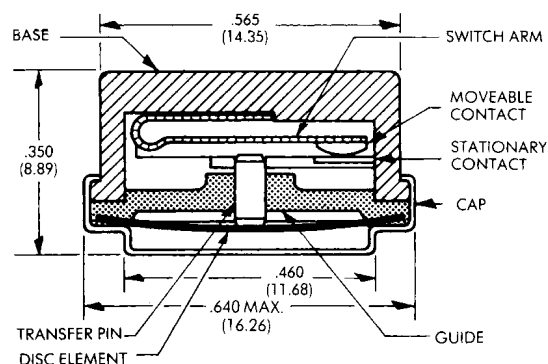

# TERMINALS AND POSITIONS

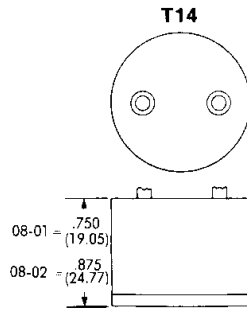
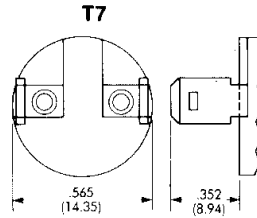
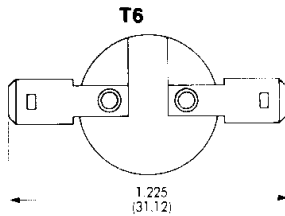
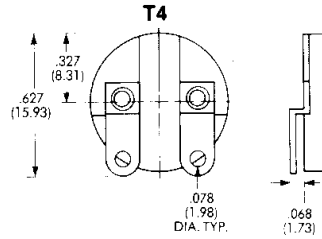
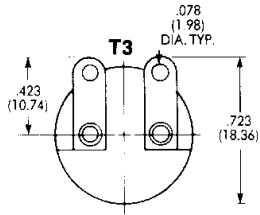
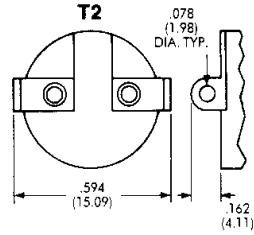
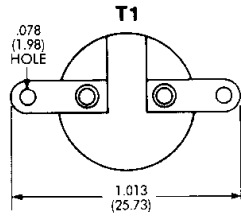

*Dimensions in brackets are millimeters.*

*Specifications subject to change without notice.*

# MOUNTING BRACKETS

**B2**

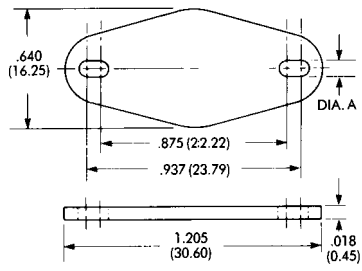

Hardware Size	Dim. A
H4	.143 (3.63)

**B6**

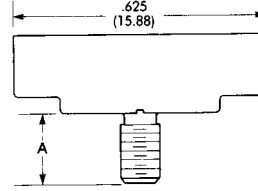

Hardware Size	Dim. A
H6	6-32 x 3/8"

Represented By: Ross & Pethel  
 Phone: 225-273-2202 [Website](#)